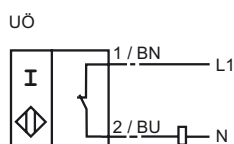
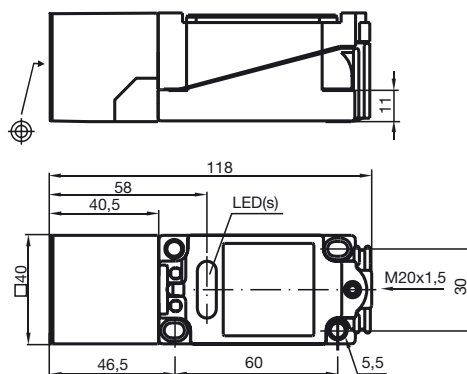

**Model Number**

NJ30+U1+UO

**Connection****Dimensions****Technical Data****General specifications**

Switching element function	AC/DCBreak function
Rated operating distance	$s_n$ 30 mm
Installation	not embeddable
Assured operating distance	$s_a$ 0 ... 24.3 mm
Reduction factor $r_{Al}$	0.4
Reduction factor $r_{Cu}$	0.3
Reduction factor $r_{V2A}$	0.85

**Nominal ratings**

Operating voltage	$U_B$ 20 ... 253 V
Operating voltage DC	20 ... 300 V
Switching frequency	$f$ 0 ... 25 Hz
Hysteresis	$H$ typ. 3 %
Short-circuit protection	pulsing
Voltage drop	$U_d$ $\leq$ 5 V
Momentary current (20 ms, 0.1 Hz)	0 ... 4000 mA
Operating current	$I_L$ 8 ... 500 mA
Off-state current	$I_r$ 0 ... 2.5 mA typ. 1.5 mA
Operating voltage display	LED, green
Indication of the switching state	LED, yellow

**Standard conformity**

Standards	IEC / EN 60947-5-2:2004
-----------	-------------------------

**Ambient conditions**

Ambient temperature	-25 ... 70 °C (248 ... 343 K)
---------------------	-------------------------------

**Mechanical specifications**

Connection type	terminal compartment
Core cross-section	up to 2.5 mm <sup>2</sup>
Housing material	PBT
Sensing face	PBT
Protection degree	IP68