

Features

- 2-channel
- Plugs directly in to field side of KF modules
- Analog or digital signal inputs
- Surge protection up to 10 kA
- Protects leads 2, 3, 5 and 6 of KF modules
- Uninterruptable operation (auto reset)

Function

This Surge Protection Barrier is designed for use with K-System (KF modules).

By simply snapping the barriers into a standard KF module, the modules are safely protected against voltage surges of different origin (e. g. lightning stroke, switching impulse, etc.). This is achieved by diverting the transient current to ground and limiting the signal line voltage to a safe level for the duration of the surge.

The end digits of the model designation correspond to the protected terminals of the respective KF module.

For additional information, refer to the manual and www.pepperl-fuchs.com.

Note: Surge Protection Barriers must always be connected to a solid and effective ground and be at the same equipotential level as the instrument it is protecting. The ground system must comply with all applicable regulations.

Assembly

Front view

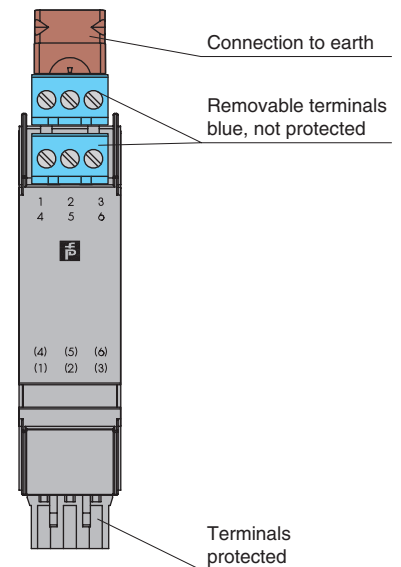

CE

Connection

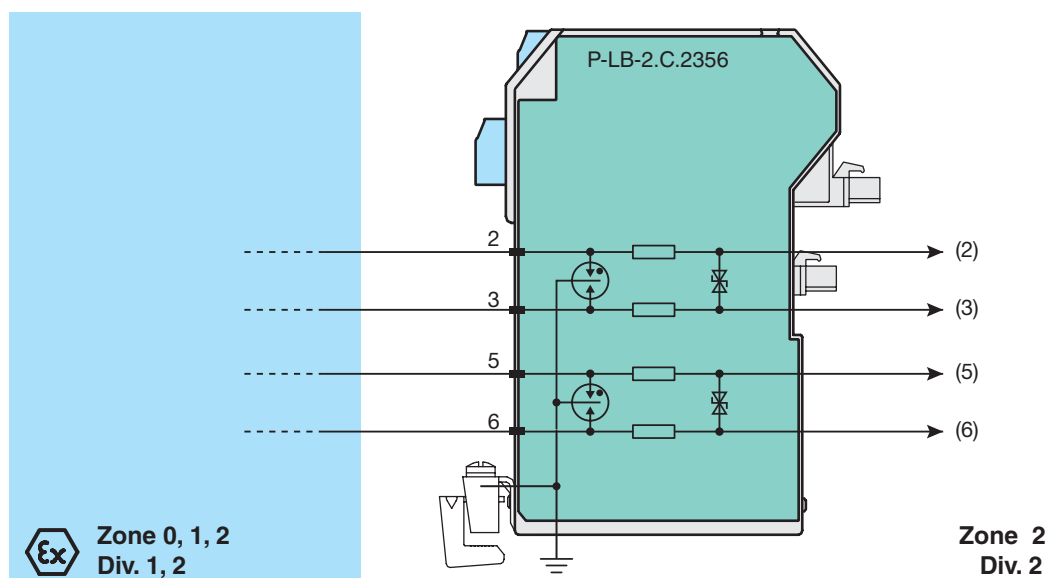

Release date 2010-09-23 13:51 Date of issue 2010-09-23 103643_ENG.xml

Signal lines	
Connection	Terminals 2, 3; 5, 6
Rated voltage	≤ 30 V
Rated current	≤ 250 mA
Leakage current	≤ 5 μA
On-state voltage	≤ 45 V
Ground insulation	≤ 500 V breakdown voltage
Conformity	
Protection degree	IEC 60529
Ambient conditions	
Ambient temperature	-20 ... 60 °C (-4 ... 140 °F)
Mechanical specifications	
Protection degree	IP20
Mass	approx. 70 g
Dimensions	20 x 62 x 115 mm (0.8 x 2.4 x 4.5 in)
Data for application in connection with Ex-areas	
EC-Type Examination Certificate	PTB 02 ATEX 2044 , for additional certificates see www.pepperl-fuchs.com
Group, category, type of protection	⊕ II (1)G [EEx ia] IIC
Voltage U _o	≤ 30 V
Current I _i	≤ 250 mA
Power P _o	≤ 1.3 W
Maximum leakage current	10 kA (8/20 μs) per conductor
Nominal response time	
Symmetrical	1 ns
Asymmetric	100 ns
Series resistor	≤ 0.5 Ω per wire
Bandwidth	≥ 40 kHz
Declaration of conformity	
Group, category, type of protection, temperature classification	⊕ II 3G EEx nA II T6
Directive conformity	
Directive 94/9/EC	EN 50014, EN 50020, EN 50021
International approvals	
CSA approval	
Control drawing	116-0187 (cCSAus)
General information	
Supplementary information	EC-Type Examination Certificate, Statement of Conformity, Declaration of Conformity, Attestation of Conformity and instructions have to be observed where applicable. For information see www.pepperl-fuchs.com .

Accessories

- 1 Connection terminal ZH-Z.AK16
- 2 Mounting block ZH-Z.AB/SS
- 3 Spacing roller when mounting on 35 mm DIN EN 60715 mounting rail:
 – installation height 15 mm: spacing roller ZH-Z.AR.85
 – installation height 7.5 mm: no spacing roller necessary
- 4 Grounding rail ZH-Z.NLS-Cu3/10

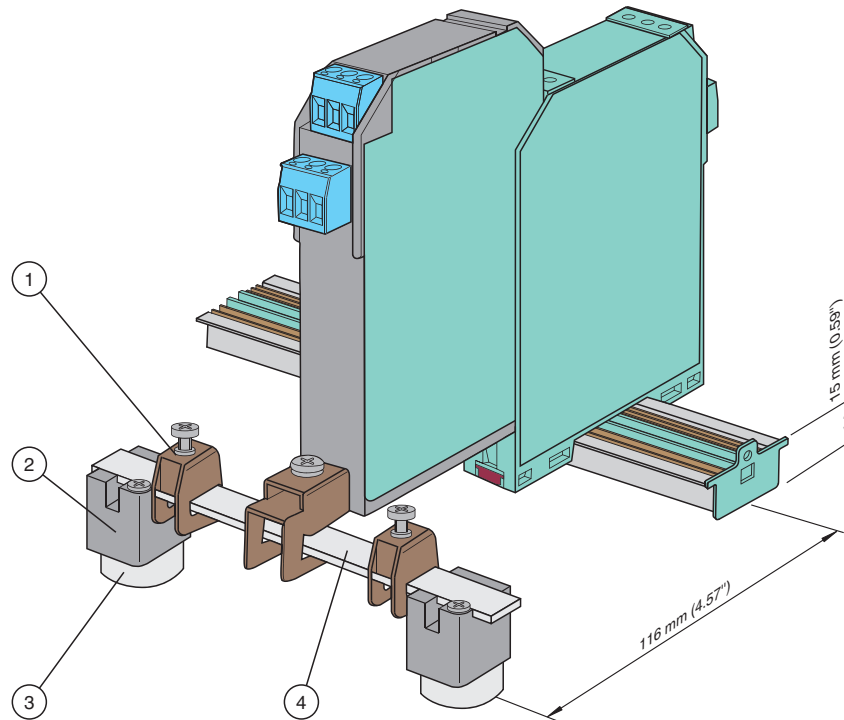

Keep the drilling distance of 116 mm between center mounting rail and center grounding bar.