



**Model Number**

**RL28-8-H-400-FFP-3019/47/115b**

Background suppression sensor with 0.2 m fixed cable and 4-pin, M12 connector

**Features**

- Special range of application: Specialised fine positioning
- Ultra bright LEDs for power on and switching state
- Good alignability due to red transmission LED
- Not sensitive to ambient light, even with switched energy saving lamps
- Protection class II

**Dimensions**

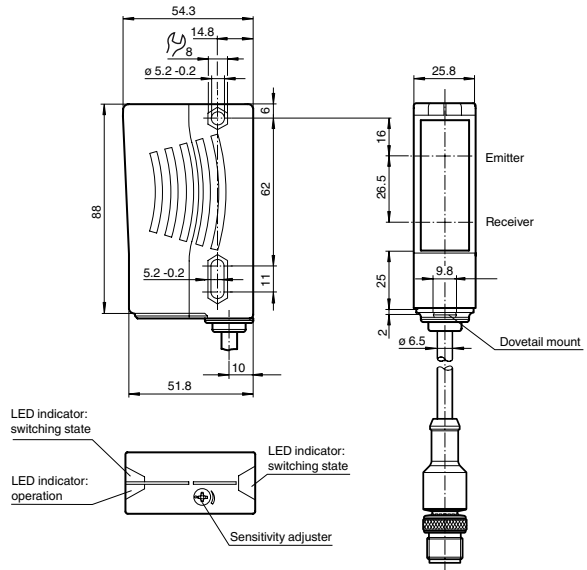

**Electrical connection**

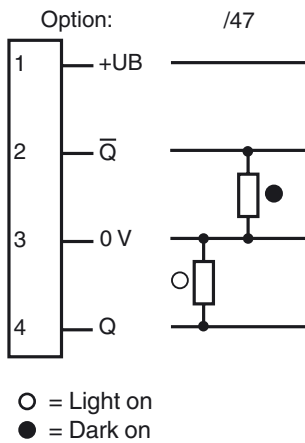

**Pinout**

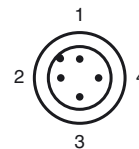

Release date: 2011-12-21 10:34 Date of issue: 2011-12-21 180711\_eng.xml

Subject to modifications without notice

Pepperl+Fuchs Group  
www.pepperl-fuchs.com

USA: +1 330 486 0001  
fa-info@us.pepperl-fuchs.com

Germany: +49 621 776-4411  
fa-info@pepperl-fuchs.com

Copyright Pepperl+Fuchs  
Singapore: +65 6779 9091  
fa-info@sg.pepperl-fuchs.com

**Technical data****General specifications**

Detection range	20 ... 400 mm
Detection range min.	20 ... 150 mm
Detection range max.	20 ... 400 mm
Background suppression	max. + 10 % of the upper limit of the detection range
Light source	LED
Light type	modulated visible red light , 660 nm
Black/White difference (6 %/90 %)	< 15 %
Diameter of the light spot	4 mm x 4 mm at a distance of 250 mm
Angle of divergence	Emitter 1.2°, Receiver 2°
Ambient light limit	50000 Lux

**Functional safety related parameters**

MTTF <sub>d</sub>	1130 a
Mission Time (T <sub>M</sub> )	20 a
Diagnostic Coverage (DC)	0 %

**Indicators/operating means**

Operating display	LED green
Function display	2 LEDs yellow ON: object inside the scanning range OFF: object outside the scanning range
Controls	Detection range adjuster

**Electrical specifications**

Operating voltage	U <sub>B</sub>	10 ... 30 V DC
Ripple		10 %
No-load supply current	I <sub>0</sub>	≤ 40 mA

**Output**

Switching type	light/dark on	
Signal output	2 PNP, complementary, short-circuit protected, reverse polarity protected , open collectors	
Switching voltage	max. 30 V DC	
Switching current	max. 200 mA	
Switching frequency	f	250 Hz
Response time		2 ms

**Ambient conditions**

Ambient temperature	-40 ... 60 °C (-40 ... 140 °F)
Storage temperature	-40 ... 75 °C (-40 ... 167 °F)

**Mechanical specifications**

Protection degree	IP67
Connection	0.2 m fixed cable with 4-pin, M12 connector
Material	
Housing	Plastic ABS
Optical face	plastic
Mass	70 g

**Compliance with standards and directives**

Standard conformity	
Product standard	EN 60947-5-2:2007 IEC 60947-5-2:2007

**Approvals and certificates**

Protection class	II, rated voltage ≤ 250 V AC with pollution degree 1-2 according to IEC 60664-1
UL approval	cULus
CCC approval	Products with a maximum operating voltage of ≤36 V do not bear a CCC marking because they do not require approval.

**Accessories****OMH-05**

Mounting aid for round steel ø 12 mm or sheet 1.5 mm ... 3 mm

**OMH-07**

Mounting aid for round steel ø 12 mm or sheet 1.5 mm ... 3 mm

**OMH-21**

Mounting bracket

**OMH-22**

Mounting bracket

**OMH-MLV11-K**

dove tail mounting clamp

**OMH-RLK29**

Mounting bracket

**OMH-RLK29-HW**

Mounting bracket for rear wall mounting

**OMH-RL28-C**

Protective cover

Other suitable accessories can be found at [www.pepperl-fuchs.com](http://www.pepperl-fuchs.com)

## Curves/Diagrams

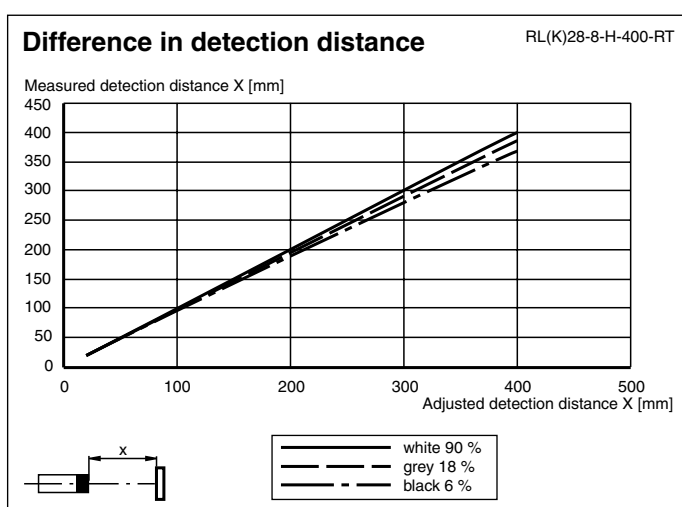
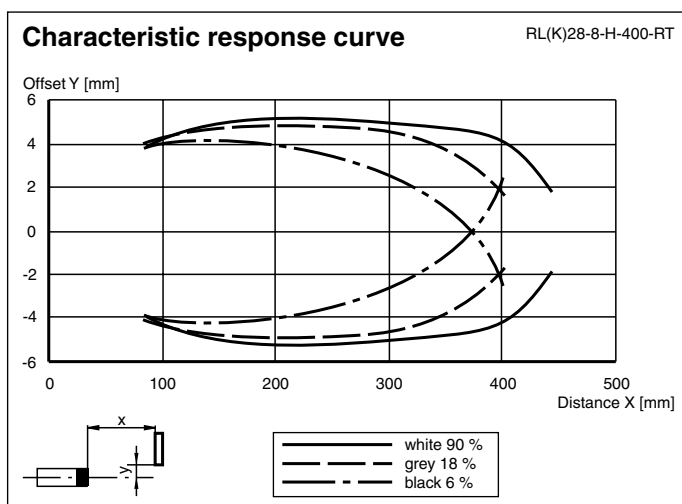

## Additional information

**Intended use:**

The transmitter and receiver are located in the same housing for direct detection sensors with background masking. Marking of objects outside the detection range is achieved by arranging the angle between the transmitter and receiver (2 receiver elements).

Objects are detected independently of their surface structures, brightness and colour, as well as the brightness of the background.

**Mounting instructions:**

The sensors can be fastened directly with fixing screws or with a support bracket (not included with delivery).

The surface underneath must be flat to prevent the housing from moving when it is tightened into position. We recommend securing the nut and screw in place with spring washers to prevent the sensor from going out of adjustment.

**Adjustment:**

After the operating voltage is applied, the LED is lit green.

Align the sensor to the background. If the yellow LED is lit, the detection range should be reduced with the detection range adjuster until the yellow LED goes out.

**Object direction:**

Place the object to be detected at the desired maximum detection range and align the light spot to it. If the object is detected, the yellow LED lights up.

If it does not light up, the detection range must be adjusted on the potentiometer until it lights up when an object is detected.

**Cleaning:**

We recommend cleaning the optical surface and checking the screwed connection and other connections at regular intervals.