



Model Number

RMS-G-RC

Radar sensor

Features

- Industrial gate opener with the ability to differentiate between people and vehicles
- Extra-wide detection area and long detection range
- Direction detection
- Easily programmable
- Programmable by remote control

Product information

The microprocessor-controlled microwave motion sensors based on the latest 24 GHz technology provide a high degree of reliability even in difficult operating conditions and can be used with all automatic (industrial) doors up to a height of 7 m. The RMS-G sensors are equipped with intelligent functions, such as vehicle detection, to enable them to be used in a wide variety of applications. The special industrial door microwave sensor can be configured so that the industrial door only opens when a vehicle approaches it, while passing pedestrians are ignored. The sensor differentiates between people and vehicles.

Release date: 2012-05-30 17:07 Date of issue: 2012-08-16 184852_eng.xml

Dimensions

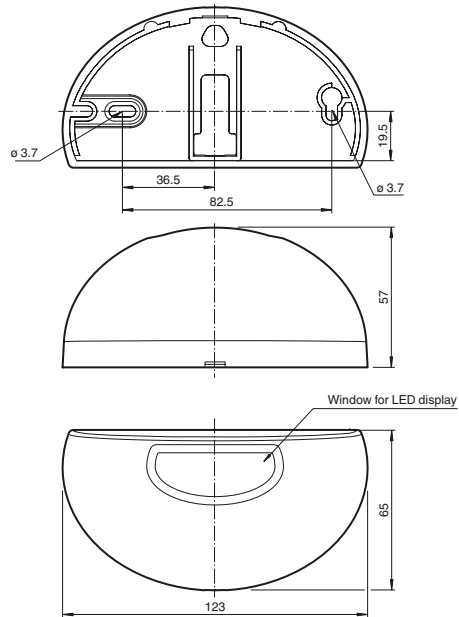

Electrical connection

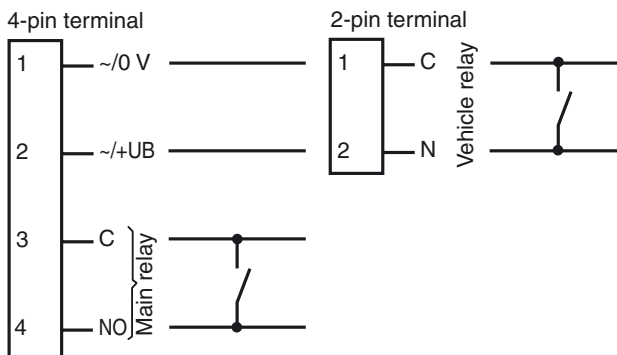

Indicators/operating means

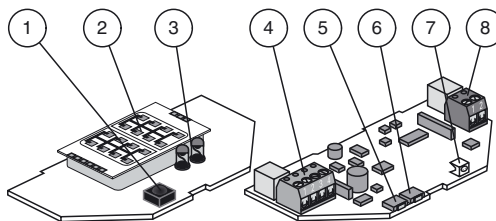

1	IR receiver
2	Antenna
3	IR-transmitter
4	Terminals (power supply/main relay)
5	Pushbutton / Menu
6	Pushbutton / Value
7	LED (red/green)
8	Terminals (vehicle relay)

Technical data

General specifications

Sensing range	7000x 6000 mm (DxW) at 5000 mm mounting height and 30° tilt angle 8000x 5000 mm (DxW) at 7000 mm mounting height and 30° tilt angle
Function principle	Microwave module
Detection speed	min. 0.1 m/s
Marking	CE
Setting angle	0 ... 40 ° in 5 ° increments
Operating frequency	24.15 ... 24.25 GHz K-Band
Operating mode	Radar motion sensor
Transmitter radiated power (EIRP)	< 20 dBm

Functional safety related parameters

MTTF _d	620 a
Mission Time (T _M)	20 a
Diagnostic Coverage (DC)	0 %

Indicators/operating means

Function display	LED red/green
Controls	Programming push-button for selection of operating modes : Direction detection , Cross traffic suppression , Vehicle detection , Switching type
Controls	Adjustment for off delay
Controls	Programming via 2 keys , alternative via remote control (Accessories ordered separately)

Electrical specifications

Operating voltage	U _B	12 ... 36 V DC , 12 ... 28 V AC
No-load supply current	I ₀	≤ 50 mA at 24 V DC
Power consumption	P ₀	≤ 1 W

Output

Switching type	NO/NC	
Signal output	2 relay outputs	
Switching voltage	max. 48 V AC / 48 V DC	
Switching current	max. 0.5 A AC / 1 A DC	
Switching power	max. 24 W / 60 VA	
De-energized delay	t _{off}	0.2 ... 5 s adjustable

Ambient conditions

Operating temperature	-20 ... 60 °C (-4 ... 140 °F)
Storage temperature	-30 ... 70 °C (-22 ... 158 °F)
Relative humidity	max. 90 % non-condensing

Mechanical specifications

Mounting height	max. 7000 mm
Protection degree	IP54
Connection	plug-in screw terminals 4-pin and 2 pin , 8 m connecting cable included with delivery
Material	
Housing	ABS, anthracite
Mass	120 g
Dimensions	123 mm x 65 mm x 57 mm

Suitable series

Series	RMS
--------	-----

Functional principle

Microwave sensors are microwave scanners that use the principle of the Doppler radar. The most important requirement for microwave detection is that the object to be detected is moving.

The microwave sensors emit microwaves of a defined frequency in order to detect people and large objects moving at speeds between 100 mm/sec. and 5 m/sec.

The microwaves emitted by the emitter are reflected back from the ground or other surfaces to the receiver. If there is no motion in the monitored zone, the emitted and reflected frequencies are identical. Nothing is detected. If people, animals or objects are moving in the monitored zone, the reflected frequency changes and therefore triggers a detection.

Based on the latest 24 GHz technology with integrated microprocessor control, these sensors provide a high degree of reliability even in difficult operating conditions. The 24 GHz frequency, known as the 'K-band,' is reserved by CETECOM for this application area worldwide.

The RMS-G series of sensors are equipped with intelligent functions to enable them to be used in a wide variety of applications. The cross-traffic suppression system can be configured so that the door only opens when vehicles or people approach it, while passing pedestrians are ignored.

With direction detection, the opening impulse can be triggered based on the direction of motion. Depending on the setting, only movements towards or away from the sensor are detected.

settings

Typical applications

- Opening impulse sensor for industrial doors
- Motion sensor for people and objects
- Activation sensors for detecting vehicles traveling at a maximum of 60 km/h (RMS-G-RC-HS)

Detection area



Accessories

RMS Weather cap

All-weather hood for RMS series microwave sensors, for ceiling and wall installation

RMS Remote Control

infrared remote control for series RMS

RMS Antenna broad

Radar antenna for wide sensing range

Other suitable accessories can be found at www.pepperl-fuchs.com

The RMS-G-RC sensor is adjusted in programming mode directly on the device using two buttons: --> 8 = pushbutton/menu; 7 = button/value. The flashing sequence of the LEDs indicates the settings. With the RMS remote control, available as an accessory, the sensor can be easily and quickly programmed from the ground. The bidirectional infrared remote control with an LCD display and self-explanatory menu interface has a range of 10 m. Even sensors with considerable installation heights can be precisely and easily adjusted.

Model number for remote control: RMS remote control

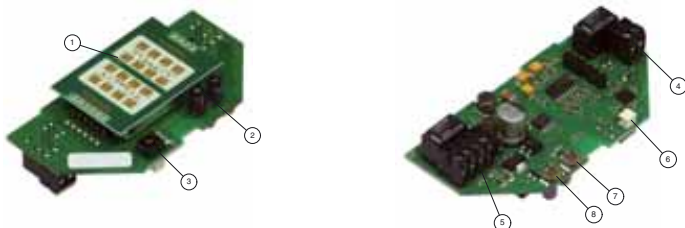

- 1) Antenna
- 2) IR emitter diode
- 3) IR receiver diode
- 4) Screw terminal (vehicle relay)
- 5) Screw terminal (voltage/main relay)
- 6) LED indicator
- 7) Button/value
- 8) Button/menu

The following properties are adjustable:

1. Dimensions of the sensing area

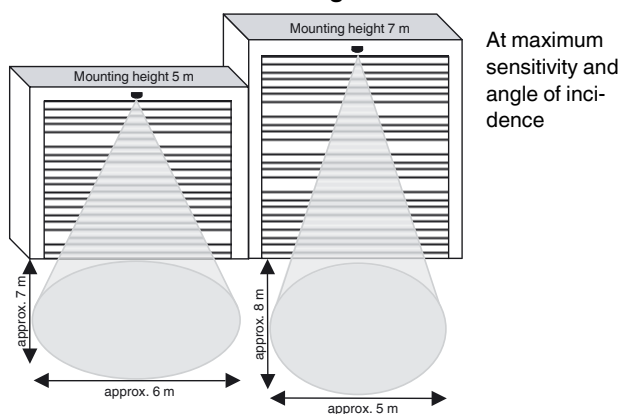

2. Dimensions of the sensing area

The size of the sensing area can be changed by adjusting the sensitivity using the buttons or remote control.



3. Position of the sensing area:

The sensing area can be rotated in 5° increments from 0° to 40°. The printed circuit board can also be inserted at an angle.

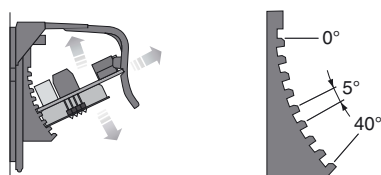

4. Detection without direction detection

Forward/backward

5. Detection with direction detection

Forward (towards the sensor)

Backward (away from the sensor)

Release date: 2012-05-30 17:07 Date of issue: 2012-08-16 184852_eng.xml

6. Cross-traffic suppression

Without suppression: door opens even in the event of cross-traffic
 With suppression: door remains closed in the event of cross-traffic

7. Detection of people/vehicles

The sensor evaluates movements of people and vehicles in different ways and switches the main relay or both relays at the same time according to the setting.
 The distinguishing between people/vehicles makes it possible to only open the door for vehicles. Approaching people must use the side entry.

8. Relay functions

The main relay always switches if it detects both people and vehicles.
 The vehicle relay only switches if vehicle detection is switched on and if a vehicle is detected and there is no pedestrian traffic.

Function display



LED green	Device ready for operation
LED red	Main relay is activated
LED quickly flashes green/red	Vehicle relay is activated
LED flashes green/red slowly	Initialization (for approx. 10 sec after switching on)
LED flashes green	Command received
LED flashes red	Fault

**Application examples:
 Distinguishes between people and vehicles**

Door with separate entry for people, door controller with 1 entry, vehicle detection switched on, only vehicle relay connected

The size of the sensing area can be changed by adjusting the sensitivity using the buttons or remote control.

Vehicle approaching	Person approaching
Vehicle relay switches (LED quickly flashes red/green)	Vehicle relay does not switch, door remains closed
The door opens	Person uses side entrance

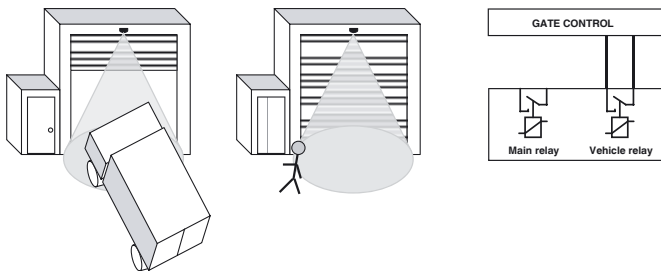

Door with no separate entry for people, door controller with two entries, vehicle detection switched on, main relay and vehicle relay connected

Person approaching	Vehicle approaching
Main relay switches (LED lights up red)	Main relay and vehicle relay switch (LED quickly flashes green/red)
The door opens half-way	Door opens fully

Release date: 2012-05-30 17:07 Date of issue: 2012-08-16 184852_eng.xml

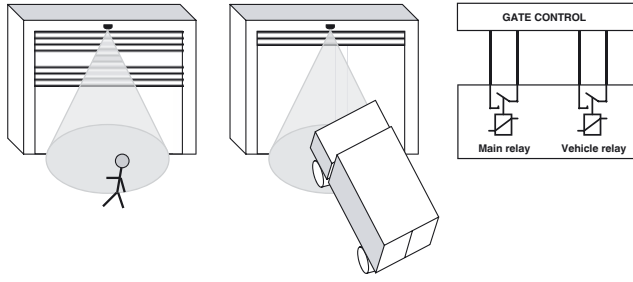

Release date: 2012-05-30 17:07 Date of issue: 2012-08-16 184852_eng.xml