

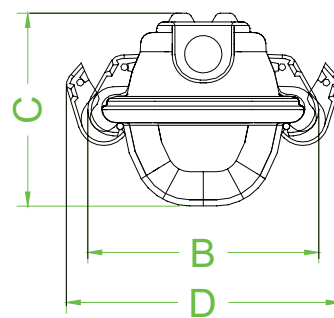

Dimensions (mm)

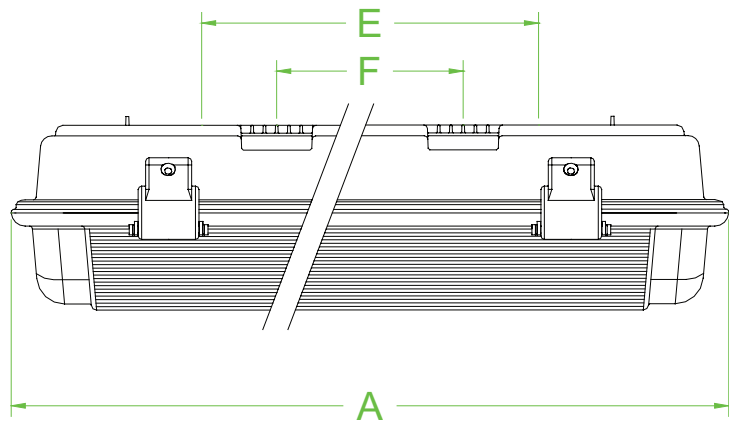

Features

- Power 18 W
- Installation in Zone 2 and Zone 22
- Electronic HF control gear
- Suitable for 220-240V AC 50/60Hz operation
- Multiple locking points on diffuser that can be hinged from both sides
- Fast opening and closing of fitting via snap shut fasteners
- Anti-glare diffuser cover
- Stainless steel surface mounting brackets supplied as standard

Technical data

Electrical specifications

Operating voltage	220 ... 240 V 50Hz / 60Hz
Operating current	0.09 A
Terminal capacity	2.5 mm ² Connection block suitable for through wiring
Control gear	high frequency electronic ballast
Fitting type	Ceiling light fitting
Lamps	T26 bi-pin fluorescent tube
Number of lamps	1
Length	600 mm (2 ft)
Power	18 W

Conformity

Protection degree	EN 60529
-------------------	----------

Ambient conditions

Ambient temperature	-20 ... 40 °C (-4 ... 104 °F)
---------------------	-------------------------------

Mechanical specifications

Cover fixing	stainless steel snap shut fasteners
Protection degree	IP66
Cable entry	
Number of cable entries	2 x M20 1 at each end

Material

Housing	Polycarbonate
Lamp cover	Polycarbonate
Reflector	0.6 mm Mild steel
Finish	Body: as moulded reflector: epoxy powder coated, white

Seal	polyurethane foam
------	-------------------

Mass	approx. 1.7 kg
------	----------------

Dimensions	
------------	--

A	685 mm
B	119 mm
C	110 mm
D	176 mm
F	340 mm
Mounting	2 x stainless steel removable mounting brackets
Grounding	Internal connection
Data for application in connection with Ex-areas	
EC-Type Examination Certificate	FTZU 02 ATEX 0313X
Group, category, type of protection, temperature class	⊕ II 3 GD Ex nA tD A II T5 T82°C
International approvals	
GOST-R approval	GOST-R B02432
General information	
Supplementary information	EC-Type Examination Certificate, Statement of Conformity, Declaration of Conformity, Attestation of Conformity and instructions have to be observed where applicable. For information see www.pepperl-fuchs.com .
Accessories	
Designation	1 x nylon non-armoured Ex e cable gland 1 x nylon Ex e sealing plug