



Model Number

GLV30-8-H-2374

Background suppression sensor connector M12 x 1, 4-pin

Features

- M30 plastic housing
- Light/Dark switching

Dimensions

GLV30-8-2500
GLV30-8-H

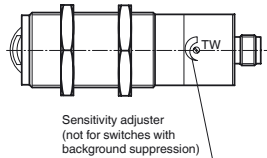
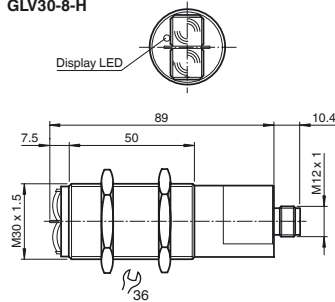

Unit connector



GLV30-LL...

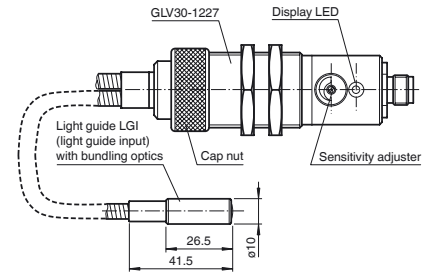
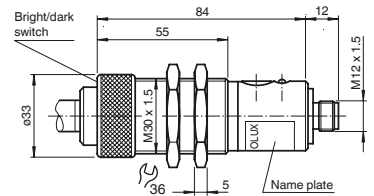

Electrical connection

Option: /47

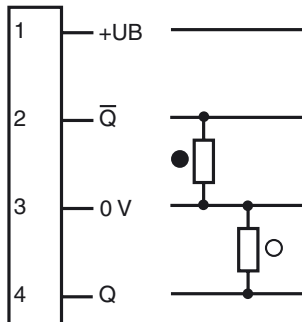

- = Light on
- = Dark on

Pinout

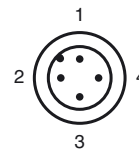

Release date: 2012-04-10 14:37 Date of issue: 2012-04-10 4-19288_eng.xml

Technical data**General specifications**

Detection range	20 ... 150 mm
Detection range min.	0 ... 145 mm
Detection range max.	0 ... 170 mm
Background suppression	starts from 180 mm
Light source	IREDD
Light type	modulated infrared light
Black/White difference (6%/90%)	< 10 mm
Approvals	CE
Diameter of the light spot	4 mm at a distance of 150 mm
Angle of divergence	± 1 °
Ambient light limit	30000 Lux

Indicators/operating means

Function display	LED yellow, lights up with receiver lit
------------------	---

Electrical specifications

Operating voltage	U_B	24 V DC ± 20 %
Ripple		10 %
No-load supply current	I_0	30 mA

Output

Switching type	light/dark on	
Signal output	2 PNP, complementary, short-circuit protected, reverse polarity protected	
Switching voltage	max. 30 V DC	
Switching current	max. 200 mA	
Switching frequency	f	35 Hz
Response time		10 ms

Standard conformity

Standards	EN 60947-5-2
-----------	--------------

Ambient conditions

Ambient temperature	-20 ... 60 °C (-4 ... 140 °F)
Storage temperature	-20 ... 75 °C (-4 ... 167 °F)

Mechanical specifications

Protection degree	IP67
Connection	Plastic connector M12 x 1, 4-pin
Material	
Housing	ABS
Optical face	plastic lenses
Mass	approx. 70 g

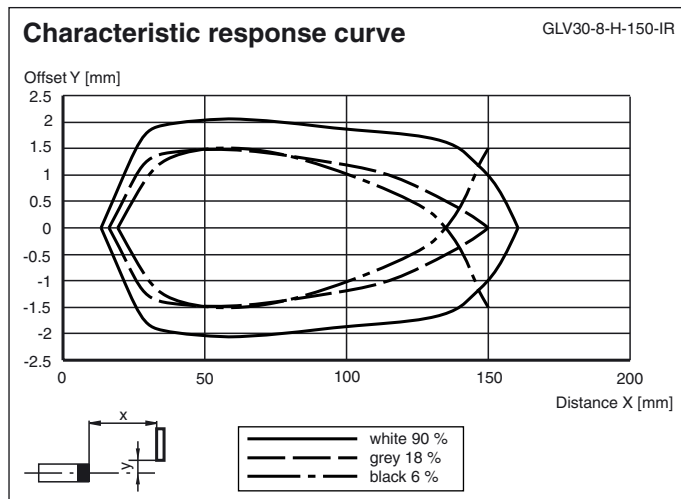
Curves/Diagrams**Accessories****V1-G-2M-PUR**

Cable socket, M12, 4-pin, PUR cable

V1-W-2M-PUR

Cable socket, M12, 4-pin, PUR cable

BF 30

Mounting flange, 30 mm

BF 30-F

Mounting flange with dead stop, 30 mm

Other suitable accessories can be found at www.pepperl-fuchs.com

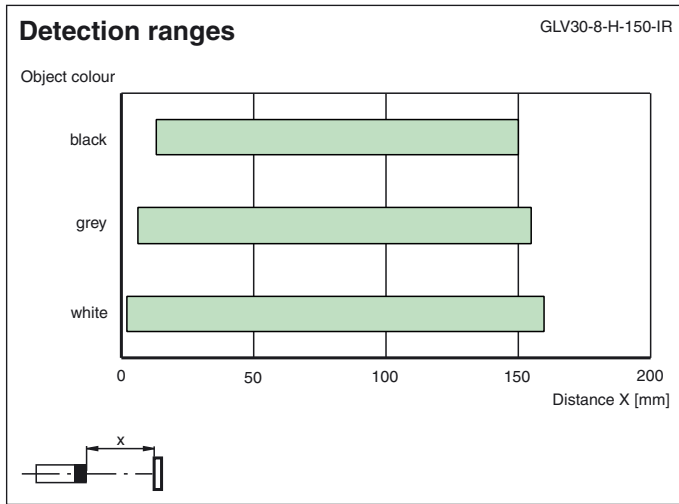

Release date: 2012-04-10 14:37 Date of issue: 2012-04-10 4 19288_eng.xml

Subject to modifications without notice

Pepperl+Fuchs Group
www.pepperl-fuchs.com

USA: +1 330 486 0001
fa-info@us.pepperl-fuchs.com

Germany: +49 621 776-4411
fa-info@pepperl-fuchs.com

Copyright Pepperl+Fuchs
Singapore: +65 6779 9091
fa-info@sg.pepperl-fuchs.com