



Model Number

RL28-8-H-700-RT/47/115

Background suppression sensor
with 2.5 m fixed cable

Features

- Ultra bright LEDs for power on and switching state
- Good alignability due to red transmission LED
- Not sensitive to ambient light, even with switched energy saving lamps
- Waterproof, protection degree IP67
- Protection class II

Dimensions

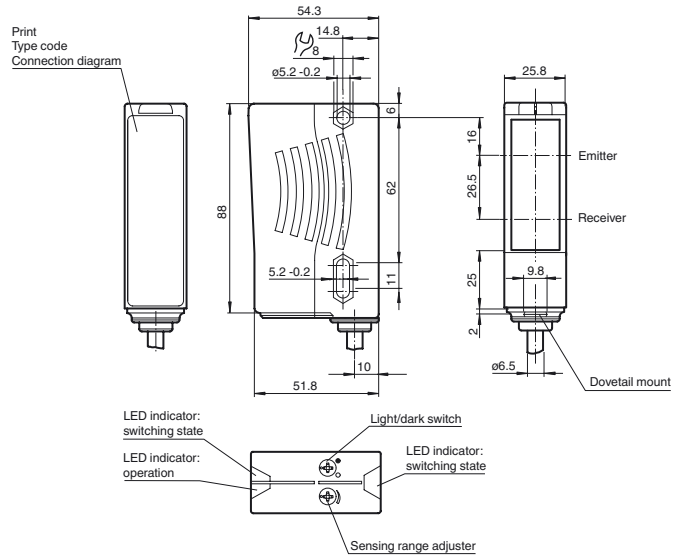

Electrical connection

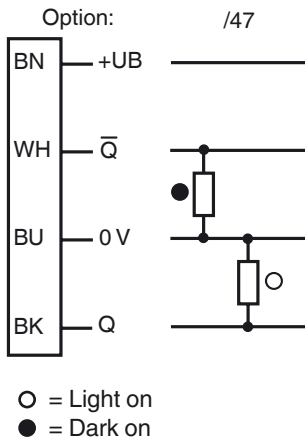

Release date: 2011-12-21 10:44 Date of issue: 2011-12-21 421179_eng.xml

Subject to modifications without notice

Pepperl+Fuchs Group
www.pepperl-fuchs.com

USA: +1 330 486 0001
fa-info@us.pepperl-fuchs.com

Germany: +49 621 776-4411
fa-info@pepperl-fuchs.com

Copyright Pepperl+Fuchs
Singapore: +65 6779 9091
fa-info@sg.pepperl-fuchs.com

Technical data**General specifications**

Detection range	20 ... 700 mm
Detection range min.	20 ... 200 mm
Detection range max.	20 ... 700 mm
Background suppression	max. + 10 % of the upper limit of the detection range
Light source	LED
Light type	modulated visible red light , 660 nm
Black/White difference (6 %/90 %)	< 20 %
Diameter of the light spot	approx. 15 mm at a distance of 700 mm
Angle of divergence	Emitter 1.2°, Receiver 2°
Ambient light limit	50000 Lux

Functional safety related parameters

MTTF _d	1130 a
Mission Time (T _M)	20 a
Diagnostic Coverage (DC)	0 %

Indicators/operating means

Operating display	LED green
Function display	2 LEDs yellow ON: object inside the scanning range OFF: object outside the scanning range
Controls	Light/Dark switch
Controls	Detection range adjuster

Electrical specifications

Operating voltage	U _B	10 ... 30 V DC
Ripple		10 %
No-load supply current	I ₀	≤ 40 mA

Output

Switching type	light/dark on switchable	
Signal output	2 PNP, complementary, short-circuit protected, reverse polarity protected , open collectors	
Switching voltage	max. 30 V DC	
Switching current	max. 200 mA	
Switching frequency	f	250 Hz
Response time		2 ms

Ambient conditions

Ambient temperature	-40 ... 60 °C (-40 ... 140 °F)
Storage temperature	-40 ... 75 °C (-40 ... 167 °F)

Mechanical specifications

Protection degree	IP67
Connection	2500 mm fixed cable
Material	
Housing	Plastic ABS
Optical face	plastic
Mass	70 g

Compliance with standards and directives

Standard conformity	
Product standard	EN 60947-5-2:2007

Approvals and certificates

Protection class	II, rated voltage ≤ 250 V AC with pollution degree 1-2 according to IEC 60664-1
UL approval	cULus
CCC approval	Products with a maximum operating voltage of ≤36 V do not bear a CCC marking because they do not require approval.

Accessories**OMH-05**

Mounting aid for round steel ø 12 mm or sheet 1.5 mm ... 3 mm

OMH-07

Mounting aid for round steel ø 12 mm or sheet 1.5 mm ... 3 mm

OMH-21

Mounting bracket

OMH-22

Mounting bracket

OMH-MLV11-K

dove tail mounting clamp

OMH-RLK29

Mounting bracket

OMH-RLK29-HW

Mounting bracket for rear wall mounting

OMH-RL28-C

Protective cover

Other suitable accessories can be found at www.pepperl-fuchs.com

Curves/Diagrams

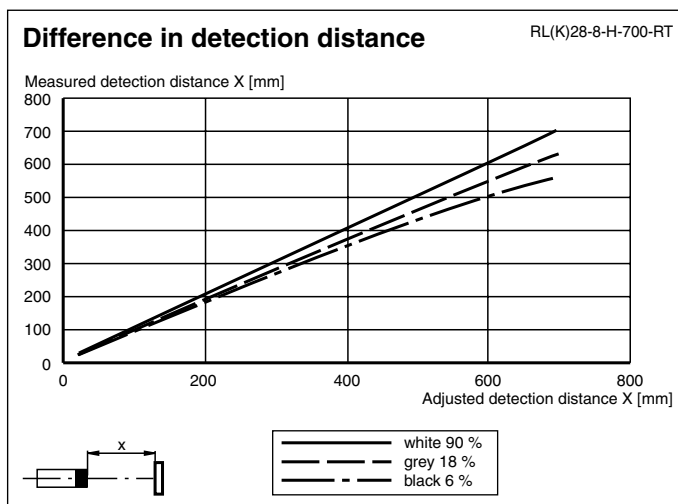
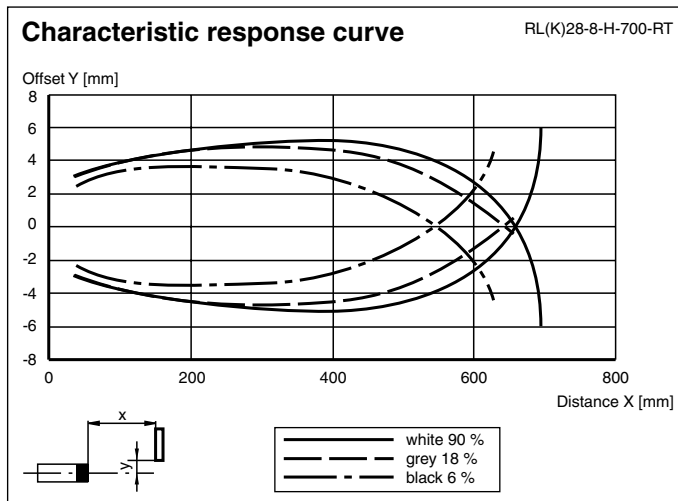

Additional information

Mounting instructions:

There are two bore holes for mounting the sensor with M5 bolts. The base surface must be flat to avoid distorting the housing during mounting. It is advisable to secure the bolts with spring washers so that the sensor does not become misaligned.

Outdoor installation:

The sensor must be protected against rain and splash-water, possibly must a cover be installed.

Adjustment:

Adjust the sensor on the background. After the connecting to the power supply the green LED illuminates. In case the yellow LEDs illuminate too, the detection range needs to be reduced with the detection range adjuster, until the yellow LEDs is switched off. If the object is moved into the detection range the yellow LEDs illuminates.

Driving inductive loads:

If the sensor are used to drive inductive loads, the following safety procedures must be carried out:
For operating voltage of 10 ... 30 V DC: fit a protection diode, max. 200 mA