



Model Number

SU18/35/40a/110/115a/126a

Fiber optic sensor
200 mm fixed cable with 4-pin, M8x1 connector

Features

- Basic line for DIN rail installation
- High power version
- Sleek design
- 3 response times selectable
- Protected against mutual interference (no crosstalk)
- Self diagnosis function

Dimensions

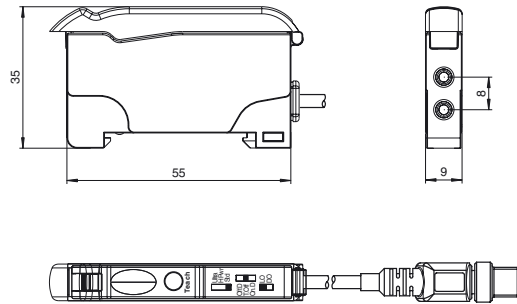

Electrical connection

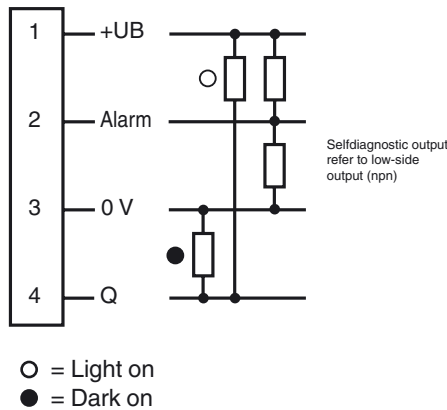

Pinout



Release date: 2011-09-16 13:44 Date of issue: 2011-10-20 808453_eng.xml

Subject to modifications without notice

Pepperl+Fuchs Group
www.pepperl-fuchs.com

USA: +1 330 486 0001
fa-info@us.pepperl-fuchs.com

Germany: +49 621 776-4411
fa-info@pepperl-fuchs.com

Copyright Pepperl+Fuchs

Singapore: +65 6779 9091
fa-info@sg.pepperl-fuchs.com

Technical data**General specifications**

Sensor range	up to 460 mm (KLR-C02-2,2-2,0-K146)
Detection range	up to 1500 mm (KLE-C01-2,2-2,0-K116)
Light source	LED
Light type	modulated visible red light , 640 nm
Ambient light limit	10000 Lux

Functional safety related parameters

MTTF _d	690 a
Mission Time (T _M)	20 a
Diagnostic Coverage (DC)	0 %

Indicators/operating means

Operating display	LED green, statically lit Power on , Undervoltage indicator: Green LED, pulsing (approx. 0.8 Hz) , short-circuit : LED green flashing (approx. 4 Hz)
Function display	LED yellow: static illumination switching state, flashes when falling short of the stability control
Controls	TEACH-IN key slide switch 2 positions: light/dark switching slide switch 3 positions: timer function - timer off, on delay 40 ms, off-delay 40 ms slide switch 3 positions: operating mode - Standard, High Power, Ultra

Electrical specifications

Operating voltage	U _B	10 ... 30 V DC
Ripple		10 %
No-load supply current	I ₀	≤ 30 mA

Output

Output of the pre-fault indication	1 push-pull output NPN/PNP , short-circuit protected	
Switching type	light/dark on, switchable	
Signal output	1 push-pull output NPN/PNP , short-circuit protected	
Switching voltage	max. 30 V DC	
Switching current	max. 100 mA , resistive load	
Voltage drop	U _d	≤ 2 V DC at 100 mA ; ≤ 0.7 V at 10 mA
Switching frequency	f	Standard mode: 3 kHz , High power mode: 1 kHz , Ultra mode: 100 Hz
Response time		Standard mode: 160 μs , High power mode: 500 μs , Ultra mode: 5 ms
Repeat accuracy	R	≤ 0.5 % of adjusted sensor range

Ambient conditions

Ambient temperature	-10 ... 55 °C (14 ... 131 °F)
Storage temperature	-20 ... 70 °C (-4 ... 158 °F)

Mechanical specifications

Protection degree	IP50
Connection	200 mm, PVC cable with M8 connector, 4-pin
Material	
Housing	PC
Mass	45 g

Compliance with standards and directives

Standard conformity	
Product standard	EN 60947-5-2:2007 IEC 60947-5-2:2007

Approvals and certificates

UL approval	cULus Listed, Class 2 Power Source, Type 1 enclosure
CCC approval	Products with a maximum operating voltage of ≤36 V do not bear a CCC marking because they do not require approval.

Accessories**KLR-C02-2,2-2,0-K146**

Plastic fiber optic - diffuse

KLR-C02-2,2-2,0-K70

Plastic fiber optic - diffuse

KLR-C02-1,0-2,0-K75

Plastic fiber optic - diffuse

KLR-C09-1,25-2,0-K76

Plastic fiber optic - diffuse

KLR-C09-1,25-2,0-K74

Plastic fiber optic - diffuse

KLR-C16-2,2-2,0-K71

Plastic fiber optic - diffuse

KLR-A32-2,2-2,0-K83

Plastic fiber optic - diffuse

KHR-C02-2,2-2,0-K131

Plastic fiber optic - diffuse

KHTR-C02-2,2-2,0-K88

Plastic fiber optic - diffuse

LHR 00-0,8-1,0-20M4

Glass fiber optic - diffuse with silicon covering

KLE-C01-2,2-2,0-K116

Plastic fiber optic - thru-beam

KLE-C01-2,2-2,0-K103

Plastic fiber optic - thru-beam

KLE-C01-2,2-2,0-K102

Plastic fiber optic - thru-beam

KLE-C01-2,2-2,0-K100

Plastic fiber optic - thru-beam

KLE-C01-2,2-2,0-K101

Plastic fiber optic - thru-beam

KLE-C01-2,2-2,0-K113

Plastic fiber optic - thru-beam

KLE-C01-1,0-2,0-K120

Plastic fiber optic - thru-beam

KHE-C01-2,2-2,0-K122

Plastic fiber optic - thru-beam

KHTE-C01-2,2-2,0-K118

Plastic fiber optic - thru-beam

LHE 00-1,1-1,0-20M4

Glass fiber optic - thru-beam with silicon covering

Bracket SU

Mounting bracket for DIN rail

Other suitable accessories can be found at www.pepperl-fuchs.com

Curves/Diagrams

Self-Diagnostic definition and operation:

5 sec. rule for light-ON (LO) and dark-ON (DO) mode

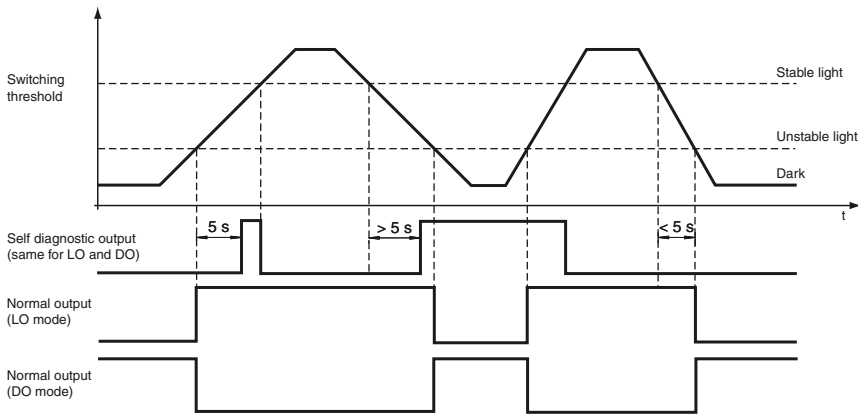

8 cyc. rule for light-ON (LO) and dark-ON (DO) mode

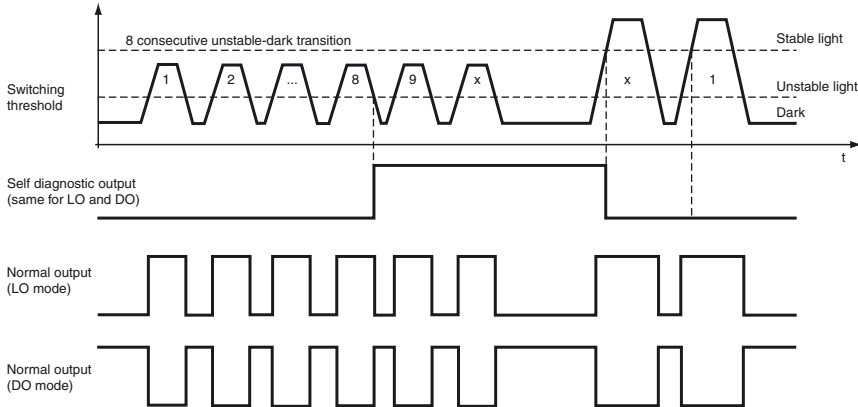

LED indicators and operating chart:

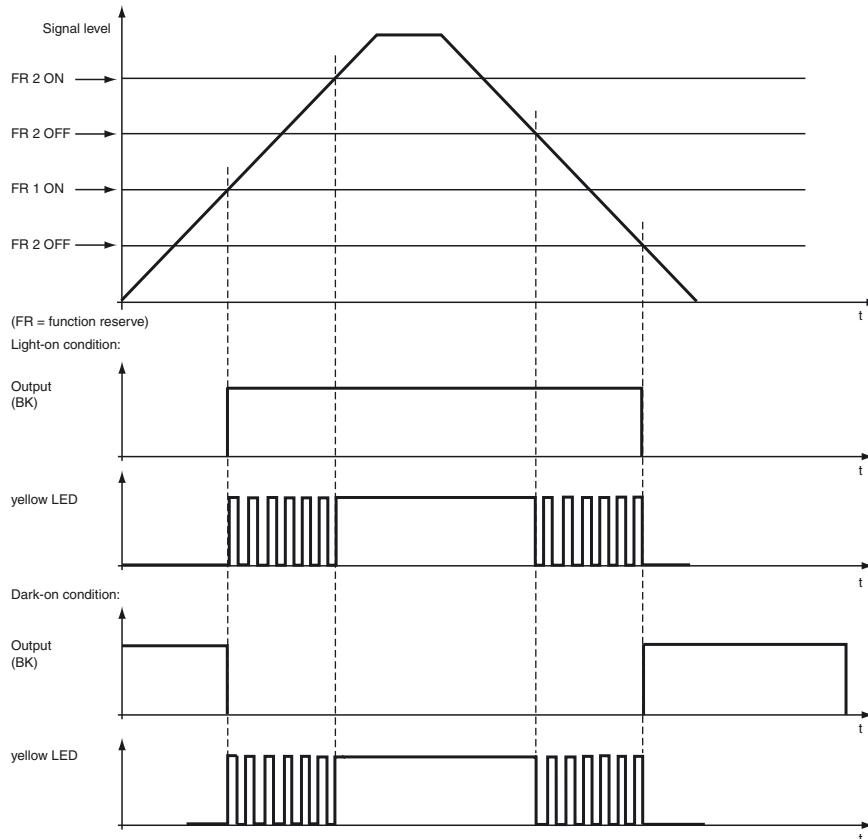

Release date: 2011-09-16 13:44 Date of issue: 2011-10-20 808453_eng.xml

Teach-in procedures

Subject to modifications without notice

Pepperl+Fuchs Group
www.pepperl-fuchs.com

USA: +1 330 486 0001
fa-info@us.pepperl-fuchs.com

Germany: +49 621 776-4411
fa-info@pepperl-fuchs.com

Copyright Pepperl+Fuchs

Singapore: +65 6779 9091
fa-info@sg.pepperl-fuchs.com

Head shape	Moun-ting	Model number	Core	Detection distance *	Fiber cross section	minimum Object size	Fiber optic length	Bend radius	Dimensions	Special features
Cylindrical	dia. 3 mm	KHE-C01-2.2-2.0-K123	PMMA	Ultra: 800 mm HiPwr: 480 mm Std: 200 mm	1 mm	0.25 mm	2 m	min. 2 mm		only 2 mm Bend radius
Right angle	dia. 15 x 5	KHE-C01-2.2-2.0-K137	PMMA	Ultra: 140 mm HiPwr: 80 mm Std: 35 mm	0.5 mm	0.15 mm	2 m	min. 1 mm		only 1 mm Bend radius
Right angle	dia. 15 x 5	KHE-C01-2.2-2.0-K140	PMMA	Ultra: 600 mm HiPwr: 350 mm Std: 150 mm	1 mm	0.25 mm	2 m	min. 2 mm		only 2 mm Bend radius
Flexible										
Threaded	M3 x 0.5 /M2.6	KLE-C01-1.3-2.0-K112	PMMA	Ultra: 800 mm HiPwr: 480 mm Std: 200 mm	1 mm	0.25 mm	2 m	min. 25 mm		4 x high Detection range with Auxiliary lens K-LA01/ 8 x high Detection range with Auxiliary lens K-LA06 Side view / Periscope with K-LA02
Threaded	M3 x 0.5	KLE-C01-2.2-2.0-K103	PMMA	Ultra: 920 mm HiPwr: 520 mm Std: 220 mm	1 mm	0.25 mm	2 m	min. 25 mm		
Threaded	M4 x 0.7 /M2.6	KLE-C01-2.2-2.0-K102	PMMA	Ultra: 920 mm HiPwr: 520 mm Std: 220 mm	1 mm	0.25 mm	2 m	min. 25 mm		4 x high Detection range with Auxiliary lens K-LA01/ 8 x high Detection range with Auxiliary lens K-LA06 Side view / Periscope with K-LA02
Threaded	M6	KLE-C01-2.2-2.0-K100	PMMA	Ultra: 920 mm HiPwr: 520 mm Std: 220 mm	1 mm	0.32 mm	2 m	min. 25 mm		
Threaded	M2.6	KLE-C01-2.2-2.0-K113	PMMA	Ultra: 800 mm HiPwr: 480 mm Std: 200 mm	1 mm	0.25 mm	2 m	min. 25 mm		4 x high Detection range with Auxiliary lens K-LA01/ 8 x high Detection range with Auxiliary lens K-LA06 Side view / Periscope with K-LA02
Cylindrical	dia. 2 mm	KLE-C01-1.3-2.0-K114	PMMA	Ultra: 920 mm HiPwr: 520 mm Std: 220 mm	1 mm	0.25 mm	2 m	min. 25 mm		
Cylindrical	dia. 5 mm	KLE-C01-2.2-2.0-K101	PMMA	Ultra: 920 mm HiPwr: 520 mm Std: 220 mm	1 mm	0.32 mm	2 m	min. 25 mm		
Bendable tip										
Threaded	M4	KLE 00-2.2-2.0-K55	PMMA	Ultra: 872 mm HiPwr: 500 mm Std: 228 mm	1 mm		2 m	min. 25 mm		
High detection range										

Release date: 2011-09-16 13:44 Date of issue: 2011-10-20 808453_eng.xml

	Std: Standard Mode, 160 μ s HiPwr: HighPower Mode, 500 μ s Ultra: Ultra Mode, 5 ms
---	--

Selection table - diffuse mode fiber optic cable

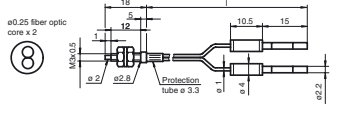
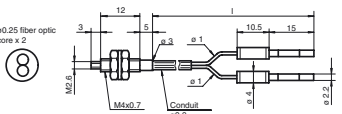
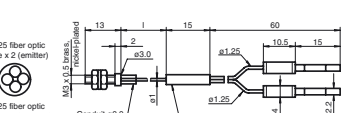
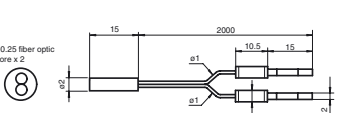
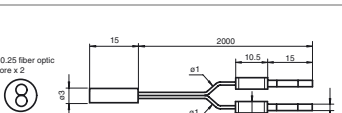
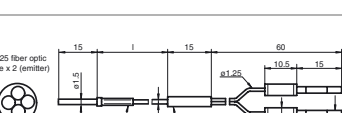
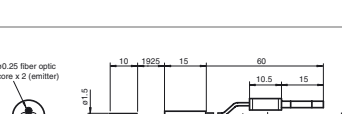
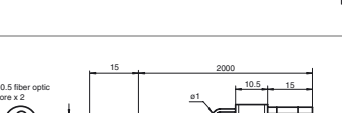
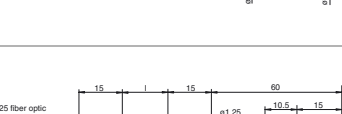
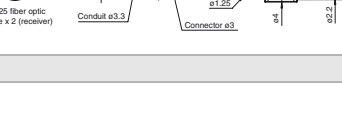
Head shape	Mounting	Model number	Core	Detection distance *	Fiber cross-section	Fiber optic length	Bend radius	Dimensions	Special features
Highly precise									
Threaded	M3 x 0.5	KLR-C02-1.0-2.0-K75	PMMA	Ultra: 12 mm HiPwr: 6 mm Std: 4 mm	2 x 0.25 mm	2 m	min. 10 mm		
Threaded	M4 x 0.7	KLR-C02-1.0-2.0-K73	PMMA	Ultra: 12 mm HiPwr: 6 mm Std: 4 mm	2 x 0.25 mm	2 m	min. 10 mm		
Threaded	M3 x 0.5	KLR-C04-1.25-2.0-K78	PMMA	Ultra: 25 mm HiPwr: 18 mm Std: 8 mm	4 x 0.25 mm	2 m	min. 15 mm		
Cylindrical	dia. 2.0 mm	KLR-C02-1.0-2.0-K91	PMMA	Ultra: 12 mm HiPwr: 6 mm Std: 4 mm	2 x 0.25 mm	2 m	min. 10 mm		
Cylindrical	dia. 3.0 mm	KLR-C02-1.0-2.0-K90	PMMA	Ultra: 12 mm HiPwr: 6 mm Std: 4 mm	2 x 0.25 mm	2 m	min. 10 mm		
Cylindrical	dia. 1.5 mm	KLR-C04-1.25-2.0-K80	PMMA	Ultra: 25 mm HiPwr: 18 mm Std: 8 mm	4 x 0.25 mm	2 m	min. 15 mm		
Cylindrical	dia. 1.5 mm	KLR-C04-1.0-2.0-K133	PMMA	Ultra: 25 mm HiPwr: 18 mm Std: 7 mm	4 x 0.25 mm	2 m	min. 15 mm		
Cylindrical	dia. 2.0 mm	KLR-C02-1.0-2.0-K87	PMMA	Ultra: 85 mm HiPwr: 52 mm Std: 25 mm	2 x 0.5 mm	2 m	min. 15 mm		
Cylindrical	dia. 3.0 mm	KLR-C04-1.25-2.0-K79	PMMA	Ultra: 25 mm HiPwr: 18 mm Std: 8 mm	4 x 0.25 mm	2 m	min. 15 mm		
Coaxial									
Threaded	M3 x 0.5	KLR-C09-1.25-2.0-K76	PMMA	Ultra: 100 mm HiPwr: 60 mm Std: 30 mm	1 x 0.5 mm Emitter 9 x 0.25 mm Receiver	2 m	min. 15 mm		only 0.5 mm light spot at 8 mm with auxiliary lens K-LA03

Release date: 2011-09-16 13:44 Date of issue: 2011-10-20 808453_eng.xml

Subject to modifications without notice

Pepperl+Fuchs Group
www.pepperl-fuchs.com

USA: +1 330 486 0001
fa-info@us.pepperl-fuchs.com

Germany: +49 621 776-4411
fa-info@pepperl-fuchs.com

Copyright Pepperl+Fuchs
Singapore: +65 6779 9091
fa-info@sg.pepperl-fuchs.com

Head shape	Mounting	Model number	Core	Detection distance *	Fiber cross-section	Fiber optic length	Bend radius	Dimensions	Special features
Threaded	M6	KHTR-C02-2.2-2.0-K88	PMMA	Ultra: 280 mm HiPwr: 180 mm Std: 80 mm	2 x 1.0 mm	2 m	min. 25 mm		- 55°C ... + 115°C
Cylindrical	dia. 5.0 mm	KHTR-C02-2.2-2.0-K89	PMMA	Ultra: 280 mm HiPwr: 180 mm Std: 80 mm	2 x 1.0 mm	2 m	min. 25 mm		- 55°C ... + 115°C
Sturdy design									
Threaded	M3 x 0.5	LHR 00-0.8-1.0-14M3	glass	Ultra: 195 mm HiPwr: 100 mm Std: 40 mm	0.8 mm	1 m	4 mm static		- 40°C ... + 180°C
Threaded	M4 x 0.7	LHR 00-0.8-1.0-20M4	glass	Ultra: 195 mm HiPwr: 100 mm Std: 40 mm	0.8 mm	1 m	4 mm static		- 40°C ... + 180°C
Threaded	M6	LHR 00-1.1-1.0-G	glass	Ultra: 230 mm HiPwr: 156 mm Std: 70 mm	1.1 mm	1 m	4 mm static		- 40°C ... + 180°C
Cylindrical	dia. 3 mm	LHR 00-1.1-1.0-Z1	glass	Ultra: 230 mm HiPwr: 156 mm Std: 70 mm	1.1 mm	1 m	4 mm static		- 40°C ... + 180°C
Cylindrical	dia. 4.5 mm	LHR 00-1.1-1.0-K1	glass	Ultra: 230 mm HiPwr: 156 mm Std: 70 mm	1.1 mm	1 m	4 mm static		- 40°C ... + 180°C
Right angle	10 mm Bar	LHR 00-1.1-1.0-K9	glass	Ultra: 230 mm HiPwr: 156 mm Std: 70 mm	1.1 mm	1 m	4 mm static		- 40°C ... + 180°C
Special design									
Rectangular		KHR-C02-1.0-2.0-K129	PMMA	5 ~ 10 mm	2 x 0.5 mm	2 m	min. 1 mm		crossed beam to background blanking only 1 mm Bend radius
Rectangular		KLR-C02-1.3-2.0-K130	PMMA	1 ~ 8 mm	2 x 1.0 mm	2 m	min. 25 mm		crossed beam to background blanking
Rectangular	3 x M3 x 0.5	KHR-A02-2.2-2.0-K127	PMMA	Ultra: 175 mm HiPwr: 112 mm Std: 50 mm	2 x 1.0 mm	2 m	min. 2 mm		only 2 mm Bend radius

Release date: 2011-09-16 13:44 Date of issue: 2011-10-20 808453_eng.xml

