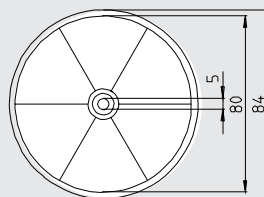
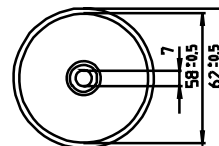
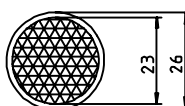

**ORR 80**  
retroreflettore**ORR 60**  
retroreflettore**ORR 20**  
retroreflettore**ORE 80 / ORE 60**

Etichetta autoadesiva da ambedue le parti per il fissaggio veloce dei retroreflettori ORR 80/60.

portatore:

schiuma di polietilene ad allineamento chiuso

colla:

colla antiinvecchiante per acrilati

colore:

bianco

copertura:

carta separatrice bianca

spessore:

1 mm (senza copertura)

forza di rottura:

30 N/25 mm

allungamento di rottura:

180% costanza alla

temperatura:

80°C (di breve durata),  
60°C (alla lunga)

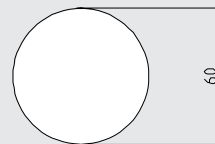
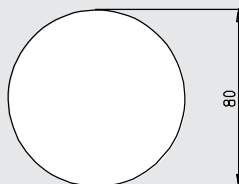
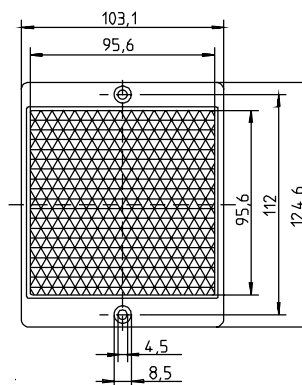
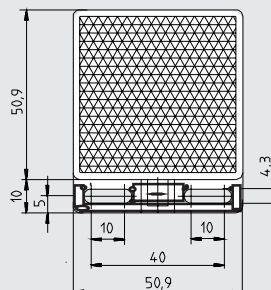
**ORR 100**  
retroreflettore**ORR50**  
retroreflettore**ORR**  
riflettore di laminato