

Control interface unit with PROFIBUS-FMS



- Conform to DIN 19 245 Parts 1 + 2
- Bus leads galvanically isolated from the power supply
- Bus connection: Terminals 'D' socket
- Power supply: Terminals
- Switchable bus termination (Side opening in housing)
- Read heads: Terminals

Operation:

The unit recognizes all the read heads connected to it and reads them cyclically once the power has been connected. Each read head is allocated with a 4 byte data field, in which the codes being read are retained in a 28 bit format. In addition, the data field contains a 3 bit read count number which is incremented with each newly read code. The read count number allows the codes that have been read to be administered in the processor unit. This enables e.g. to distinguish between a new code being present or the same code being read several times. One bit in the data field indicates the status of the code evaluation. (No code carrier present or a parity error has occurred during reading)

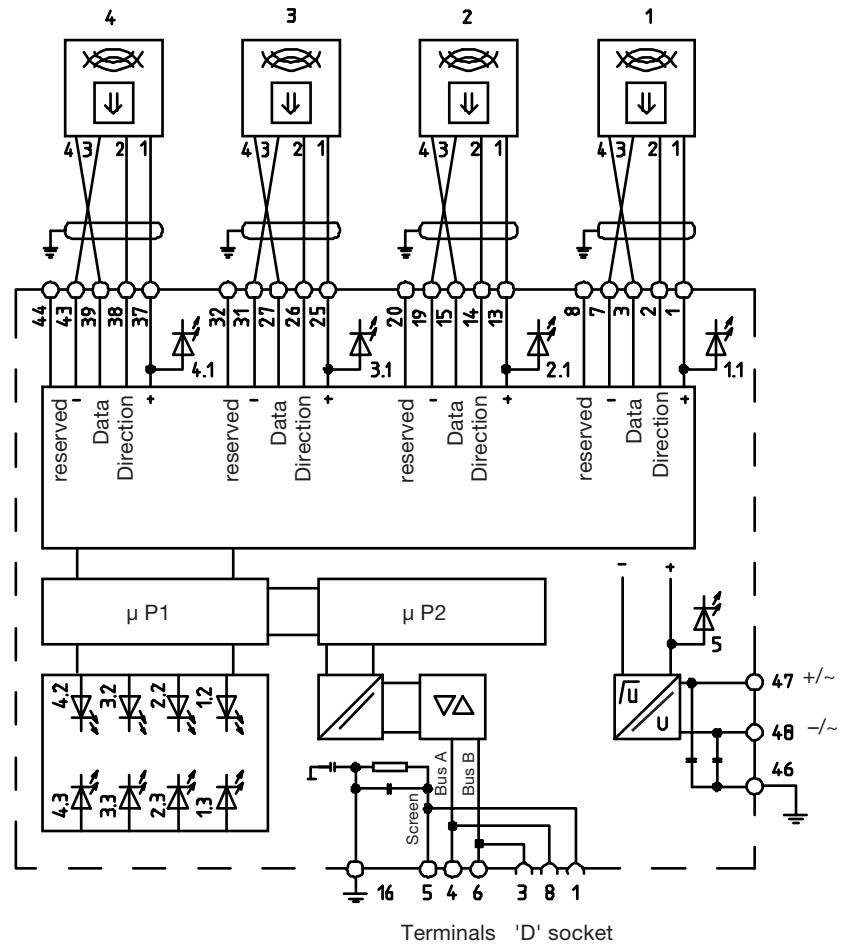

Dimensions

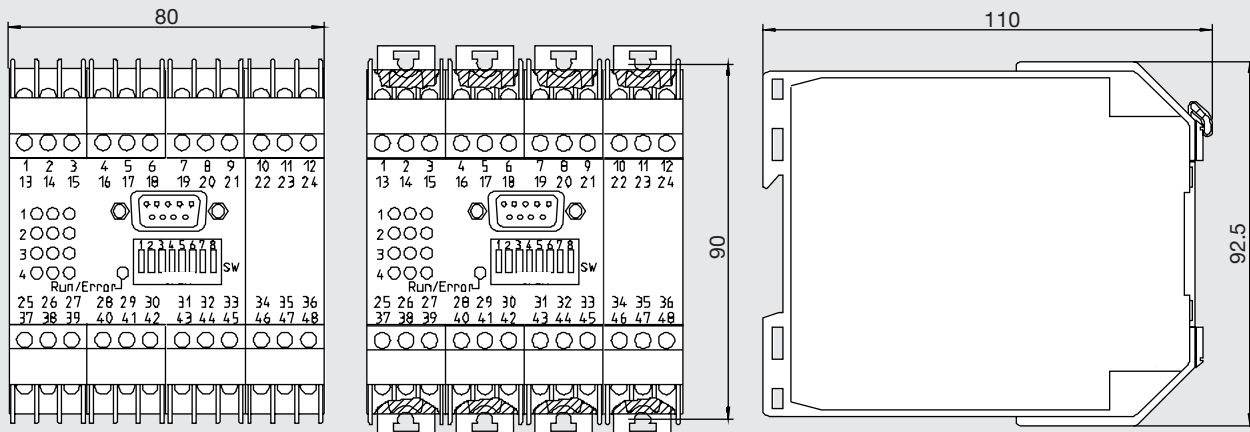

Date of Issue 20.10.1997

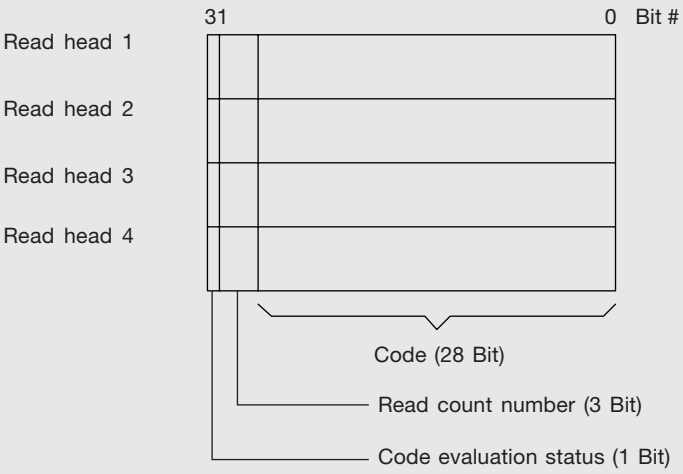
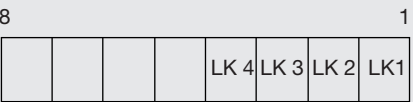
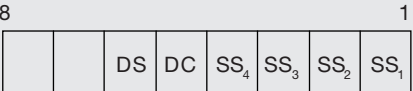
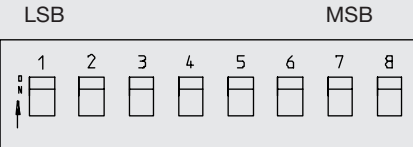
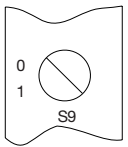
<p>Object register:</p>	<p>Index 40 - Input data Array (4 x 8 bit value string 4) without sub-indexing</p>  <p>Index 41 - Read head status Single variable (8 bit value string 1)</p>  <p>LK 1 to LK 4 = Read head defect / not connected</p> <p>Index 42 - Parameter Single variable (8 bit value string 1)</p>  <p>SS₁ to SS₄ = Read head deactivate / activate DC = Security flag; DC = 1: Data carriers are not read as Code carriers (Default = 1, version with default = 0 also available) DS = Double sided read; DS = 1: Double sided read activated (Default = 0)</p>
<p>Access points and connection types:</p>	<p>Default - SAP (NIL) MSZY SAP 0 MSZY SAP 2 MSAZ SAP 3 MSAZ Max. PDU length: 128</p>
<p>DIP switches:</p>	 <p>Switches 1 - 7: Station address Switch 8: Minimum station delay time Off: 500 bit times On: 200 bit times</p>
<p>Bus termination:</p>	 <p>Switch 9: Bus termination 0 = OFF 1 = ON</p>

Date of issue 20.10.1997

Type coding	IRI-KHD2-4HB1	IRI-KHA6-4HB1
Power supply Supply voltage Ripple Current consumption Quiescent current With active read head	20.4 V DC ... 27.6 V DC ≤ 10% Max. < 450 mA 120 mA (Typically) 190 mA (Typically)	90 V AC ... 253 V AC, 50 ... 60 Hz
Indicators Ident Read head active Code carrier recognized Stability control Bus Run/Error green LED Run/Error red LED	3 LEDs per read head status - Green - Yellow - Red 1 LED Device status (Two color) Device operational / Communication active Device error/Transmission error	
Housing	K-System, 80 mm (4 TE)	
Bus connection Transmission rate Address setting Range of functions	Conform to DIN 19 245 Parts 1 + 2 500 kbaud (187. 5 kbaud on request) DIP switches Slave Functions - Initiate - Identify -Write - Abort - Get-OV - Status - Read	
Environmental conditions Operating temperature Storage temperature Moisture Protection class to EN 60529	248 Kelvin ... 343 Kelvin (-25 °C ... +70 °C) 248 Kelvin ... 358 Kelvin (-25 °C ... +85 °C) Max. 75% rel. humidity IP20	
Mechanical Construction Mounting Connections	Makrolon modular terminal housing, flammability class UL 94: V - 0 By clipping onto 35 mm standard rail to DIN EN 50 022 or by two screws through extendable tabs Self opening instrument terminals, maximum conductor cross sectional area 2x2.5 mm ²	